

Homemade BATTERIES

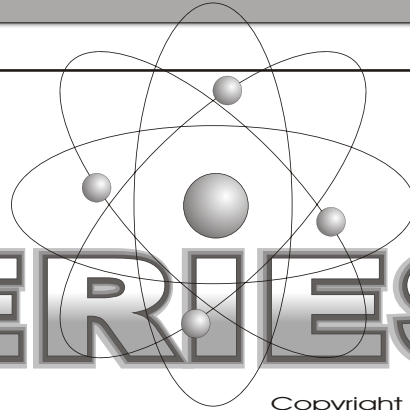

Copyright 2003

Learn how to build a powerful homemade water cell battery right in your own home. Research has proving that you can build a simple water cell battery, powerful enough to run a car as well as your home lighting. Although these plans are simple in design, you can provide yourself with hours of fun as well as doing complex research in this field. To recharge your battery you simply replenish the water tank with fresh water and your battery is fully charged again. Many people like to use pure water with just a touch of Chlorine or rain water. Rain water has some acid in it.

WARNING! Although these plans talk in part about using water, some of these plans may suggest experimenting with Clorox bleach and liquid plumber, These chemicals are dangerous, please keep all of your experiments away from children and animals, always wear gloves and protective eye wear. Some of these experiments are not recommended for children under 18 years of age. We are not responsible for anything, you experiment at your own risk!

NOTICE: Below is a side view drawing of large copper and aluminum plate cells, they can be any shape that you want. All I can say is, Play around with different exotic metals and you will be surprised! Zinc and copper work great!

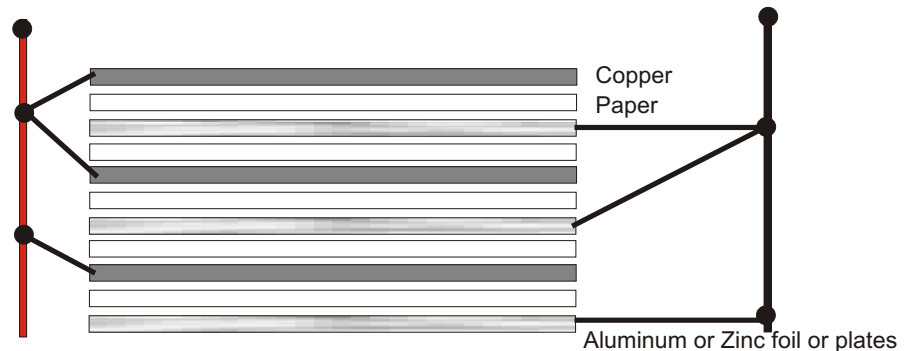

There are many uses for homemade batteries cells. They are great for Emergency home lighting, as well as running small motors etc.. In many countries electricity can only be used for a few hours a day. which effects many people around the world who live in these areas, there economys just can not afford to run there power plants for long periods at a time. Many of these people have to use candles and oil lamps just to be able to eat or to read a book.

We have given away much of our technology to help many of these people, But there are still thousands of cities all over the world that can not afford to build such machines or they can not get the parts.

This is why we have introduced our Homemade Battery plans, It is a cheap alternative energy source for these people to use. Even if they built small cheap water batteries, these small batteries can still be used for low lighting which is better than nothing.

A good source for low emergancy lighting is the use of a low amp LED diode, by using a bright L.E.D light in series with a 1 meg resistor connected to any type of battery, you will get a light source that can last for months! if you left the circuit in figure 1 on for 24 hours a day the batteries would last up to 6 months, and if you use the light only at night it would last 12 to 14 months! Figure 1 is very easy and cheap to build.

Don't know what an LED Light is? It is a light Emitting DIODE, You can buy them from any Radio shack or electronics supply store. Or search the internet for electronic supplies. They are very cheap and easy to build.

You will want to buy a bright Yellow or orange LED, You can build many of them to go all around your home, The more you build the more light you will have in your home. Again use a LED light that is recommended for the voltage you are going to use.

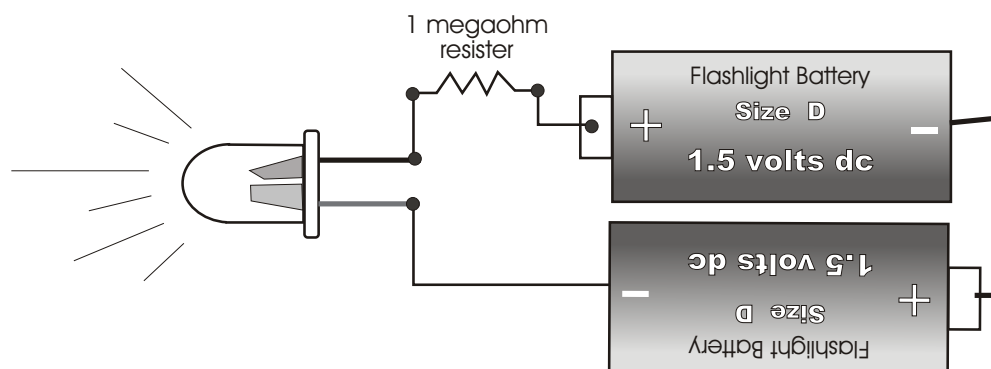

Fig. 1

First we start off with the basics. Small and simple, but fun experiments to get you familiar with the subject. A much more sophisticated and powerful system can be made using car batteries or PVC type. Your Fuel is nothing but rain water mixed with a small solution of Clorox Bleach that you can buy at any store. Just like when you fill your car up with gasoline, you fill your batteries up with water. A great and powerful system for indoor and outdoor night lighting. These batteries will last a life time. you can buy old car batteries at any automotive Junk Yard or build your own PVC tube type.

do not try to charge these batteries. if you are going to use 12 volt Car batteries, **THEN BE VERY CAREFUL THERE IS ACID INSIDE OF THEM.**

Drain acid out in a safe place away from animals and humans. YOU BUILD ALL OF THIS AT YOUR OWN RISK, WE ARE NOT RESPONSIBLE FOR ANYTHING IN THESE PLANS, BUILD AT YOUR OWN RISK.

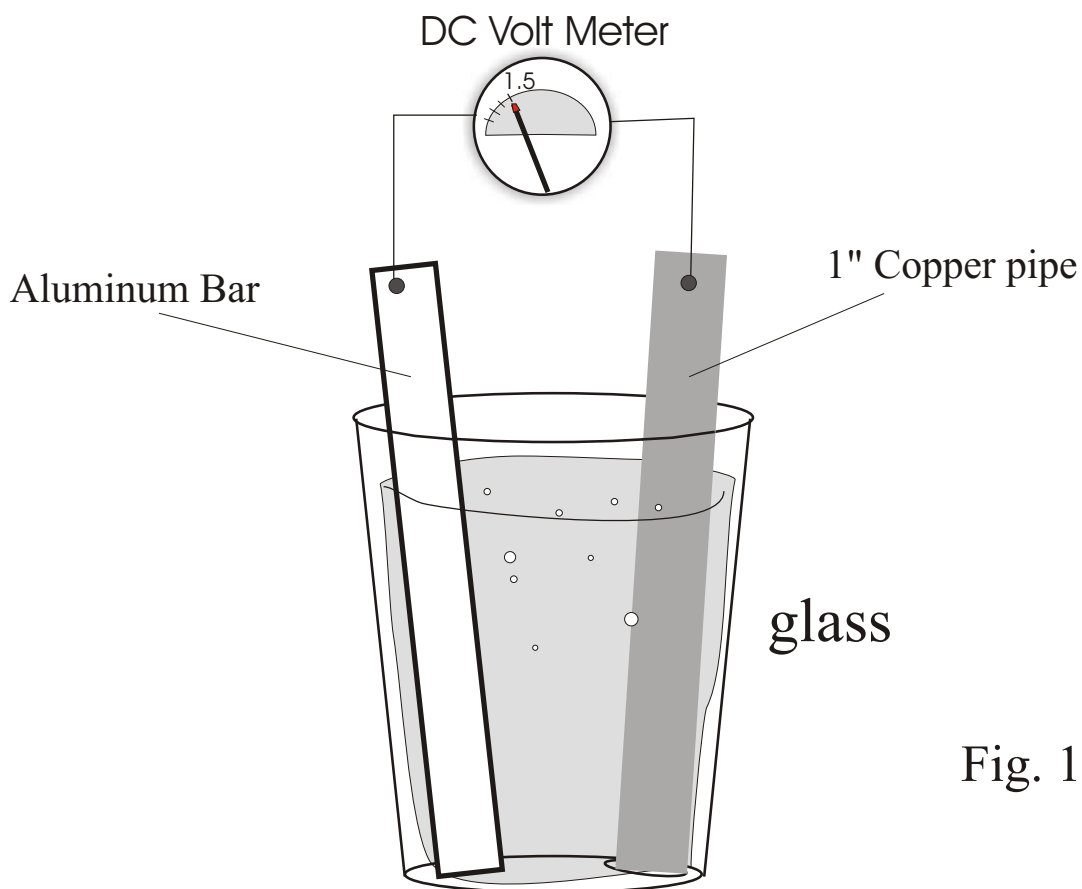

Fig. 1-b

Glass is filled with tap water with 1/4 teaspoon of Bleach.

In fig 1-b, you should get about 1.5 volts DC with a small milliamp current. The more Bleach you use the more amperage you will get, but the faster the metals will corrode. The idea is to make your batteries where they only need to be refueled once every 3 months or so, and the metal will corrode very little. To do this you will need to use a teaspoon of bleach to every gallon of water. But this will not be enough amperage to do anything with so what you must do is add many cells together in series, (Fig 1b, counts as one cell) Just as you would Flashlight batteries. When you refuel, each cell must be turned over to let the old water solution out. You can refuel up to 6 months if you use regular tap water with a pinch of bleach, But again the less bleach the more cells you will need to add to get the voltage and amperage you want for your particular needs. The Aluminum and copper will last a very long time, The Aluminum will corrode faster than the copper. to keep your battery system working at it's best It is suggested that you take out and clean the metals with water and lightly sand the copper ones and then replace them back into the containers every 3 to 6 months. We estimate both metals to last about 4 to 5 years and maybe longer?????

Aluminum can be a bit expensive, But you can cut your cost by using Old Aluminum cans. The aluminum can will be the Negative DC and the copper pipe will be the Positive. you will get a much more powerful cell using the can as so.

Notice: Coke cans are clear coated on the inside, you will have to use Hydrochloric Acid to remove the coating. Be careful!

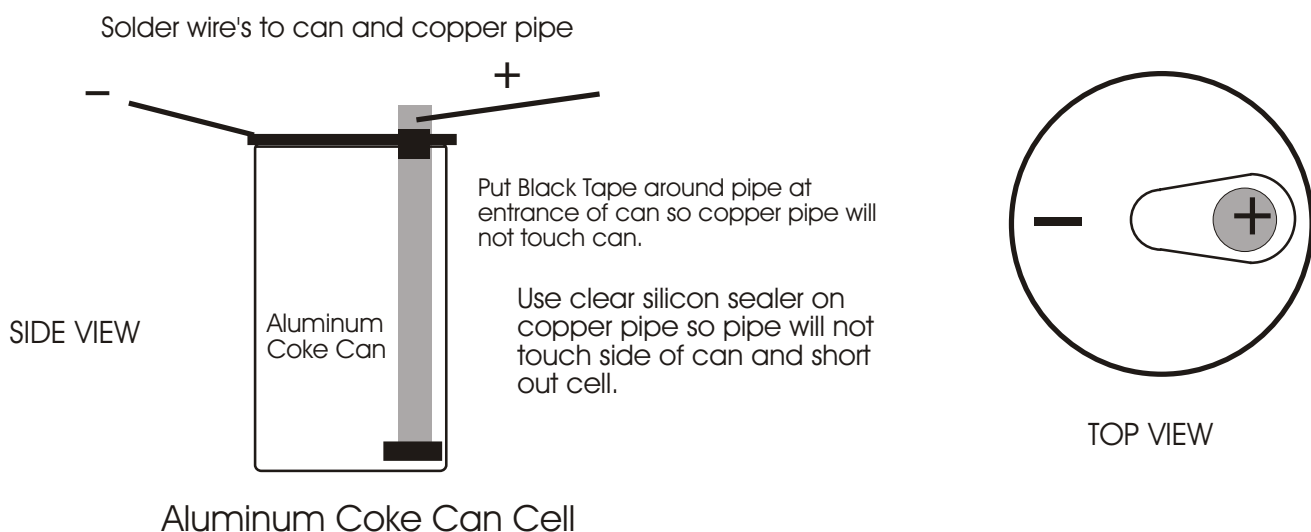

Aluminum Can Batteries / Cells

Output
about 24 vdc

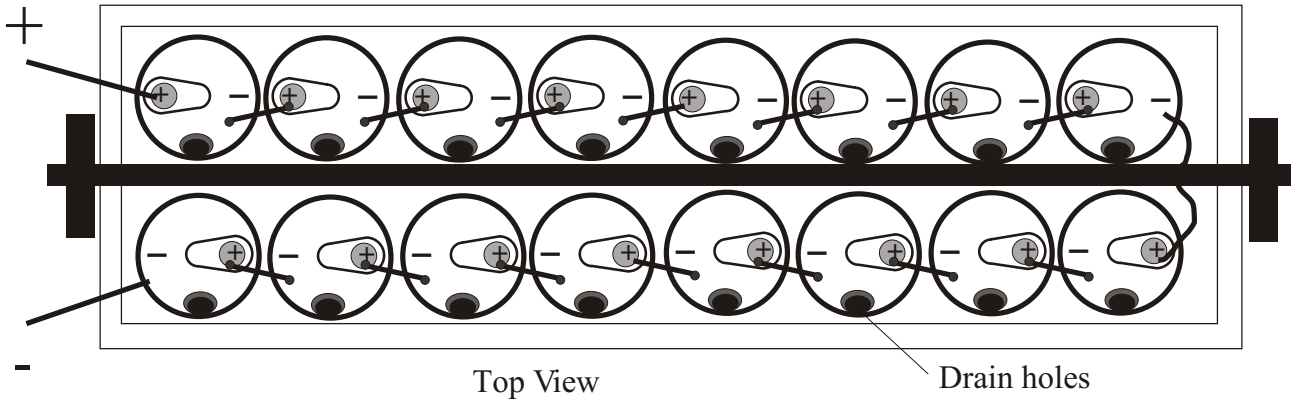

This is a top view of a rotateable wood box assembly, When it is time to change water (Fuel), you simply turn box over and all the water will drain out. (of course each can must be Glued with silicon on the bottom of each can to the bottom of each box.

Or the box can be stationary, With a small slit space on both sides of the box toward the bottom, so you can get to each can. and pull out a small 1/4" cork stopper from each can to let the water drain out.

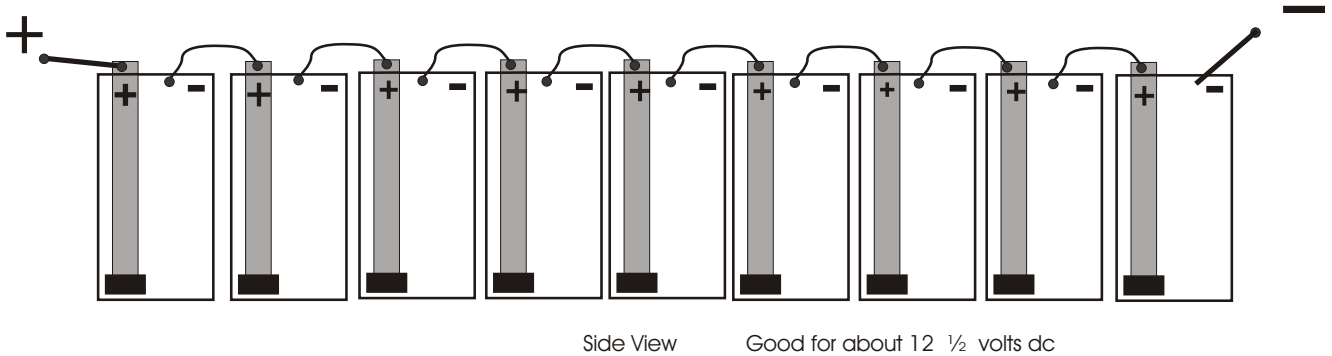

Creative Science & Research

P.O. Box 557

New Albany, IN. 47151

www.fuelless.com or www.fuellesspower.com

The drawings on page 4 shows each can, or battery cell, hooked up in series, Just like a store bought dry cell battery, when you connect the batteries in series from positive to negative, the voltage is increased. When you connect your battery cells in parallel the voltage stays the same but the amperage (Power) is increased!

For parallel connections, connect each cell + to + and - to -.

To increase the amperage as well as the voltage, connect 6 cells or more in series which will count as one battery, which equals 6 vdc x 100 milliamp.

Build 5 more of these batteries and then connect them in parallel this will give you more amperage. You will then have 6 volts dc x 600 milliamps!

Make sure that each cell does not touch the other (Aluminum to Aluminum) when you are connecting them in series or parallel or they will short out.

Or use 8 can cells to = 12 vdc

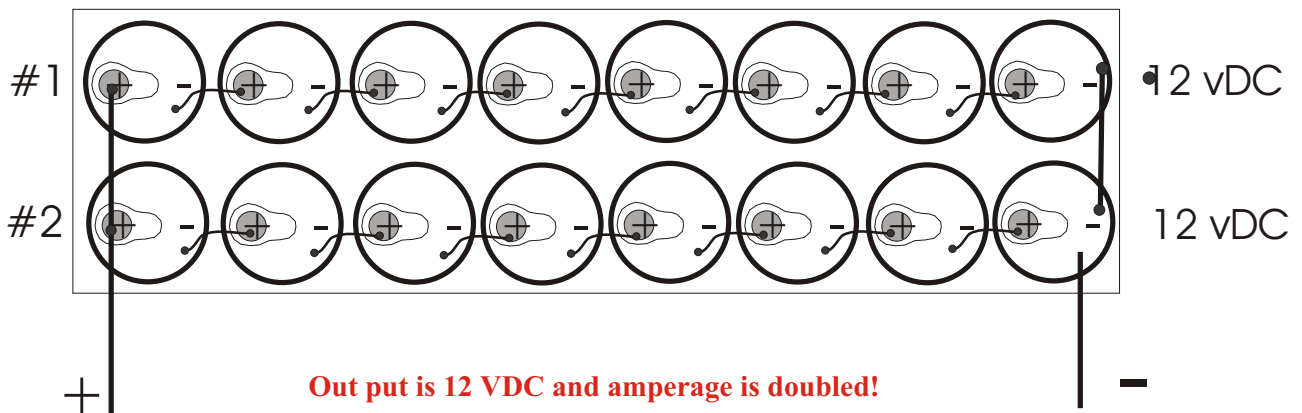

Basically what we are doing here is using water as a fuel to generate electricity with 2 different type of metals causing a chemical reaction in each cell. If you use these batteries out side in the summer in direct sun light you will get even more amperage.

Most everything you will need can be purchased at any hardware store, The nice thing about using an Aluminum can is, you can get them Free just by going on the side of the roads and collecting them. If you buy your Aluminum be prepared, it is not cheap. For extremely high amperage cells using only 16 cans, Use Pure Clorox bleach in each cell can, You will get a lot of power for a short time.(About 48 hrs.) The metals will corrode fast but In some emergency cases you may need it..

A Long Lasting, Yet Powerful Battery! The closer the copper pipe is to the aluminum or zinc, the more amperage and voltage you will get. A good way to make this type of cell is to use thin copper foil or sheeting, which you can purchase at any Art Store, or check with your local hardware store, If they do not have it they can order it for you. If you are still having trouble finding a good Copper or Aluminum supplier check the web. You can find just about anything you want on the web if you now what to ask it to search for. I would simply type in, Copper Sheeting, or Copper foil. You may also want to try copper supplies.

At any rate, you can still use the aluminum can technique, but this time you will need to cut off the tops of all the cans, then you can use acid to remove the inner can clear coating or sand it by hand using a wood Dow rod and a small piece of sand paper glued or taped to the end of the dow rod, you can then sand by hand or you can connect the wood dow rod to an electric drill.

You will now need to cut your copper foil to fit inside of the can, and then apply spacers or plastic sheet spacers about 1/8" thick, or 1/8" space in between the copper and the aluminum. The closer the better! Wood spacer could be used also and glued into place.

Then simply connect each cell in series as on page 4 or 5 and fill each can up with tap water or pure water mixed with a touch of bleach or chlorine.

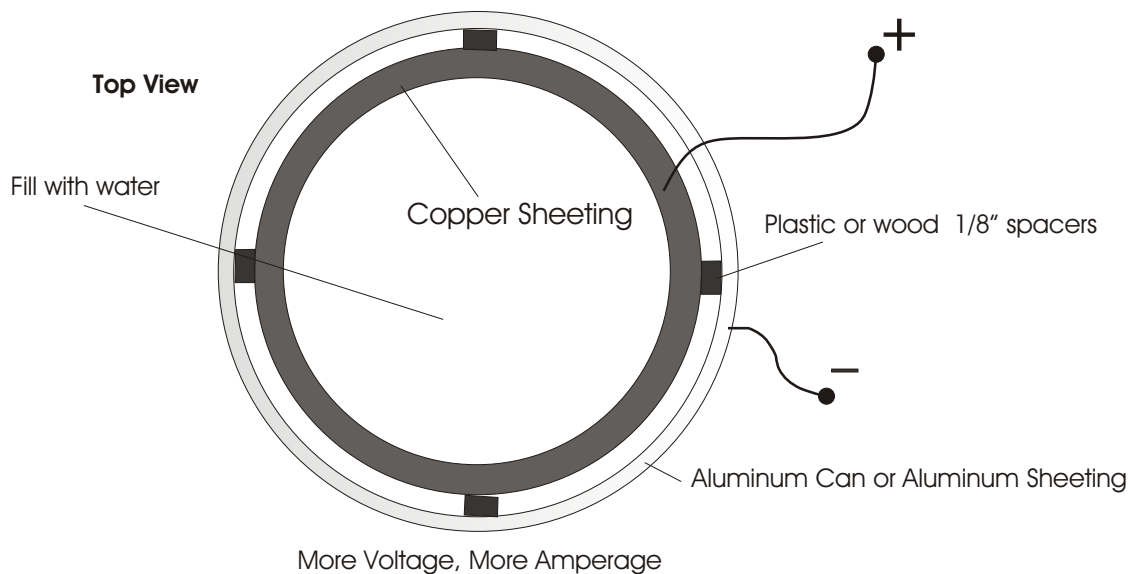

You can use Liquid Plumber which you can purchase in most stores. It is an acid that is used to eat through hair that is clogged in you Drain pipes. You can use Liquid Plumber instead of bleach as well as any type of acid such as the acid you find in lemons etc.. You can try making different cells using these acids full strength as well as deluting them with water. But your main goal is to use 1 part acid to 10 parts of water.

ALWAYS USE A PLASTIC FACE MASK HELMET AND RUBBER GLOVES WHEN HANDLING ACID. Agin you will need to delute the acid in the water. Never Pour Water into the Acid, pour the Acid into the water. **Read all warnings on the acid label that you purchase!**

When you use Acid it will corrode the electrodes about the same as using Clorox. We recommend using Clorox Bleach.

Please Keep all of these Chemicals out of the reach of Children.

PVC Pipe Batteries

Making PVC Pipe Battery Cells is a little more expensive but well worth it. It is more convenient and produces a lot more power.

there are two ways you can do it using the Aluminum as your negative electrode, You can use aluminum cans soldered together and placed inside of the PVC pipe or you can use expensive Aluminum Rod or bar that you can buy from any hardware store.

We suggest using the Aluminum Cans. The Cells can be as tall as you like 3 foot to 8 foot. But we prefer 24 cells at 6 foot. They can be mounted across a garage wall and each one will have an on off valve located at the bottom of each PVC Cell. Each drain will be connected to a PVC 2" or so Drain Pipe which can be drained and directed to the out doors. The on and off valves you can buy at any hardware store they are PVC and are Cheap. Well good luck and God Bless, I hope we have giving you some good information here that you can use during Emergency's If you have any suggestions that you would like to see added to these plans please write us.

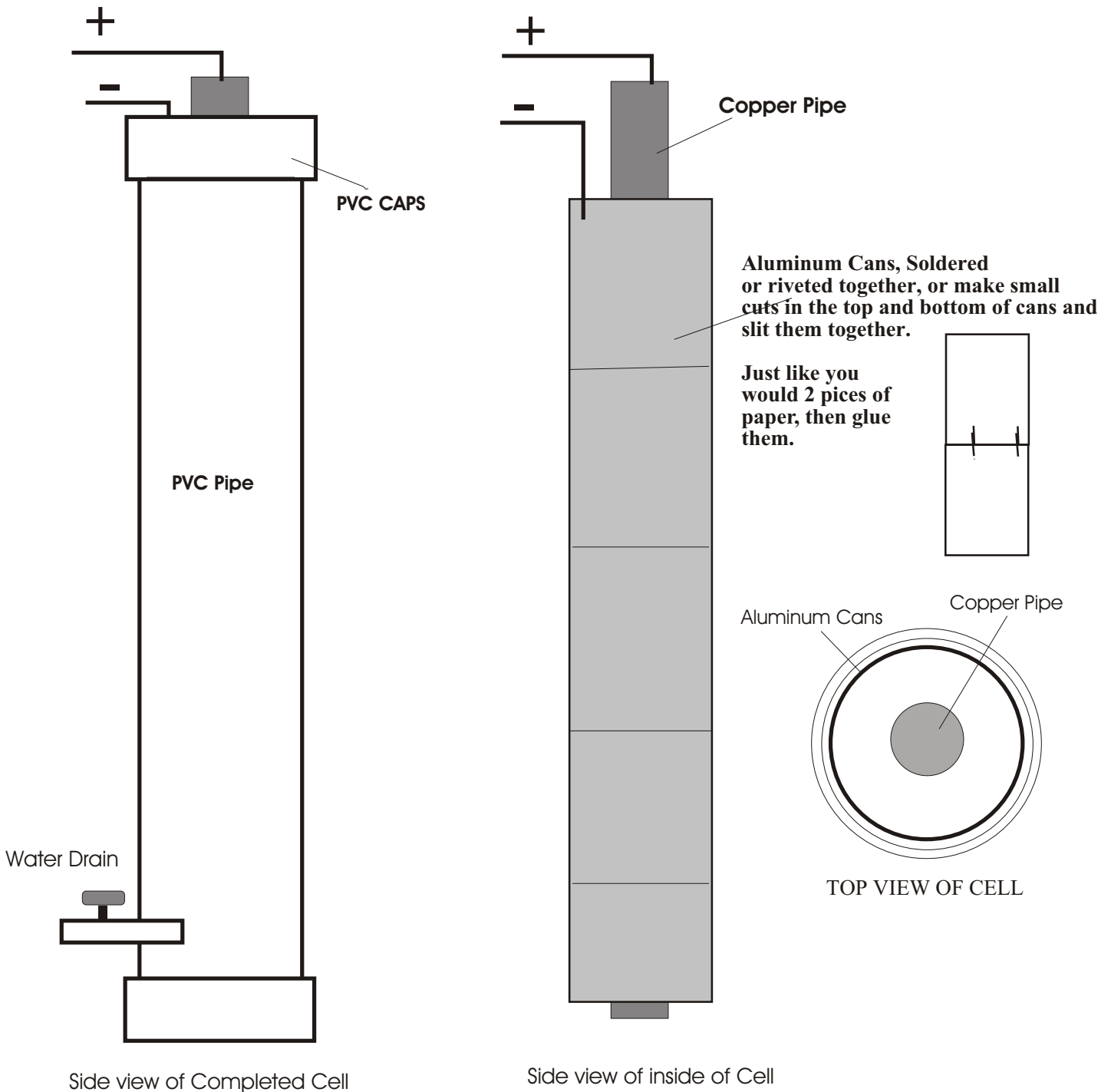

Cut the Bottoms and tops off of Aluminum Coke Cans. You can Solder them together or cut small slits in each can so they can be joined together then you can glue them with silicon, if you glue on the outside of each can then make sure you allow enough space for the can assembly to fit into the PVC pipe. Make sure all can are touching. You may have to sand the printing ink off of the tops of them, Just make sure they are all making a good electrical connection.

Now that you have learned some basics on how to make a homemade battery, the following will show you how to make an even more powerful cell battery, using copper and aluminum sheeting foil or 1/8" thick or less sheeting. Simply cut as many copper, aluminum and cloth sheets as you can and then piece them together. It is best to drill or punch 2, 1/4" holes into the exact same areas on all of the materials, so you can use 2 wood Dow rods as guides. Cut a 14" x 12" piece of 1/2" plywood and then drill 2 holes for your Dow rods to go into and glue them into place using glue that can withstand water. Now place your copper plate down first over the Dow rods and onto the base of the plywood, then 2nd, place your cloth spacer on top of the copper and through the Dow rods. 3rd, place your aluminum sheet over top of the cloth spacer as you did the copper piece. Simply repeat this over and over until you have about 100 pieces all stacked. Now wrap cloth string around the entire battery to secure it well, Now solder and or use bolts to connect all the copper leads and then do the same for the aluminum leads. And you are done, the battery is ready to be placed in a water container and immersed in water.

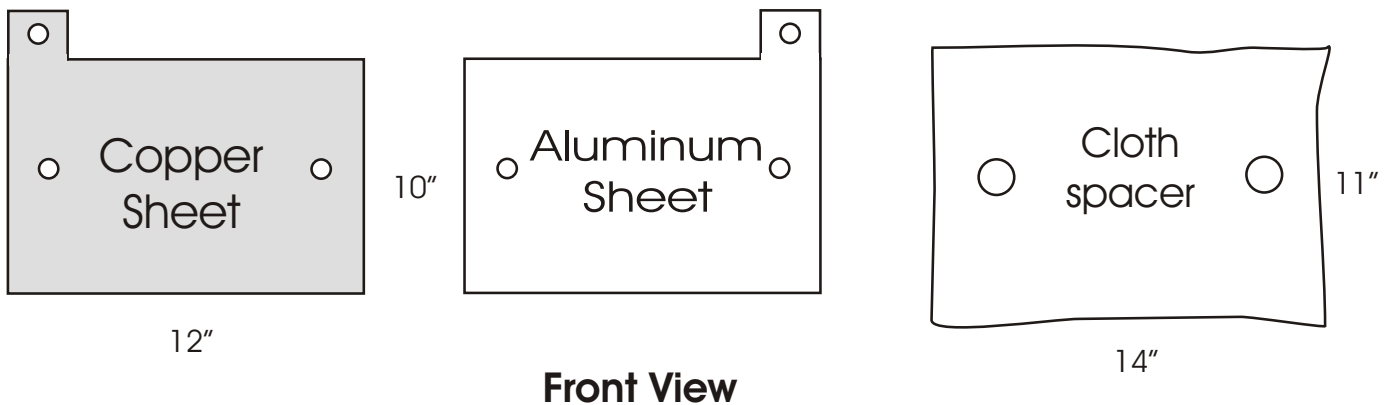

Front View

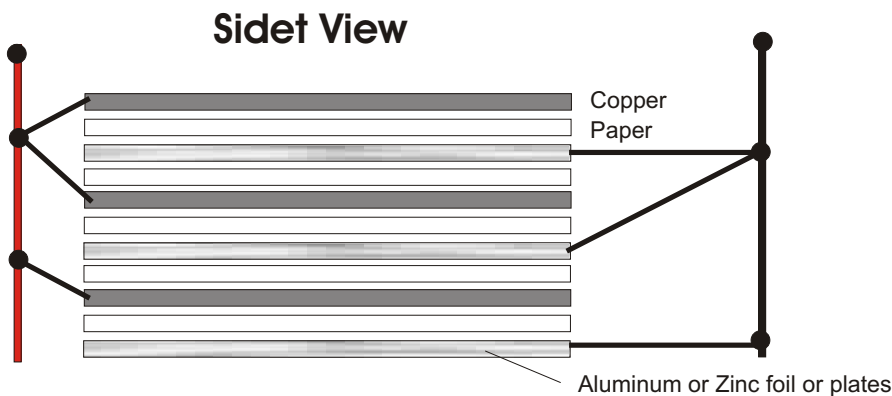

Side View

Sandwich them together very tightly!
But keep them as flat as you can.

Add hundreds of cells, think BIG!

The more cells you add the more amperage you will have, which means the more lights you can run in your home etc...

Free News

**Sent in by one of our good customers out in California!
This guy went the extra mile and did an awesome job!**

Two Methods of Cell Construction\Water Battery

Individual cells must be separated by an electrical insulating barrier, such as plastic sheet. Any other insulating material may be used if it has both electrical and water insulating ability. Without this barrier, electrical charges will move in both directions between the differing plates, canceling any great potential flow. In the example illustration below, arrows represent direction of moving electrical charge. A simplified meter is measuring the sum charges actually moving in the circuit.

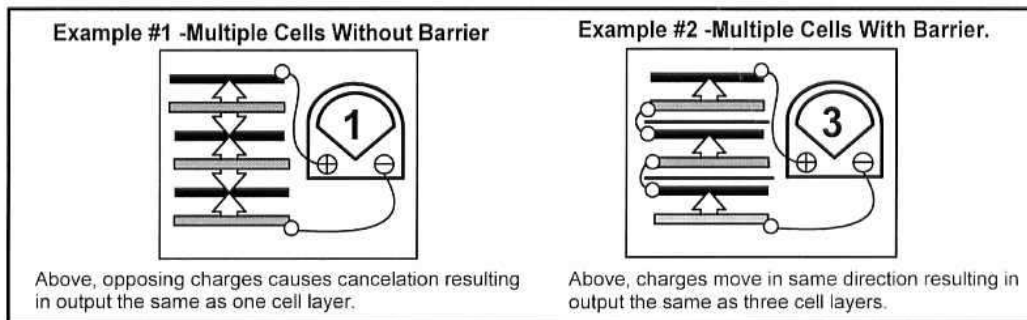

Below, the two methods of cell construction differ only in their barrier design. The metals used, electrolyte, and plate separators are the same. Also note that the larger the plates, the more amperage/charge-flow is achieved between the plates; while the voltage/charge remains the same.

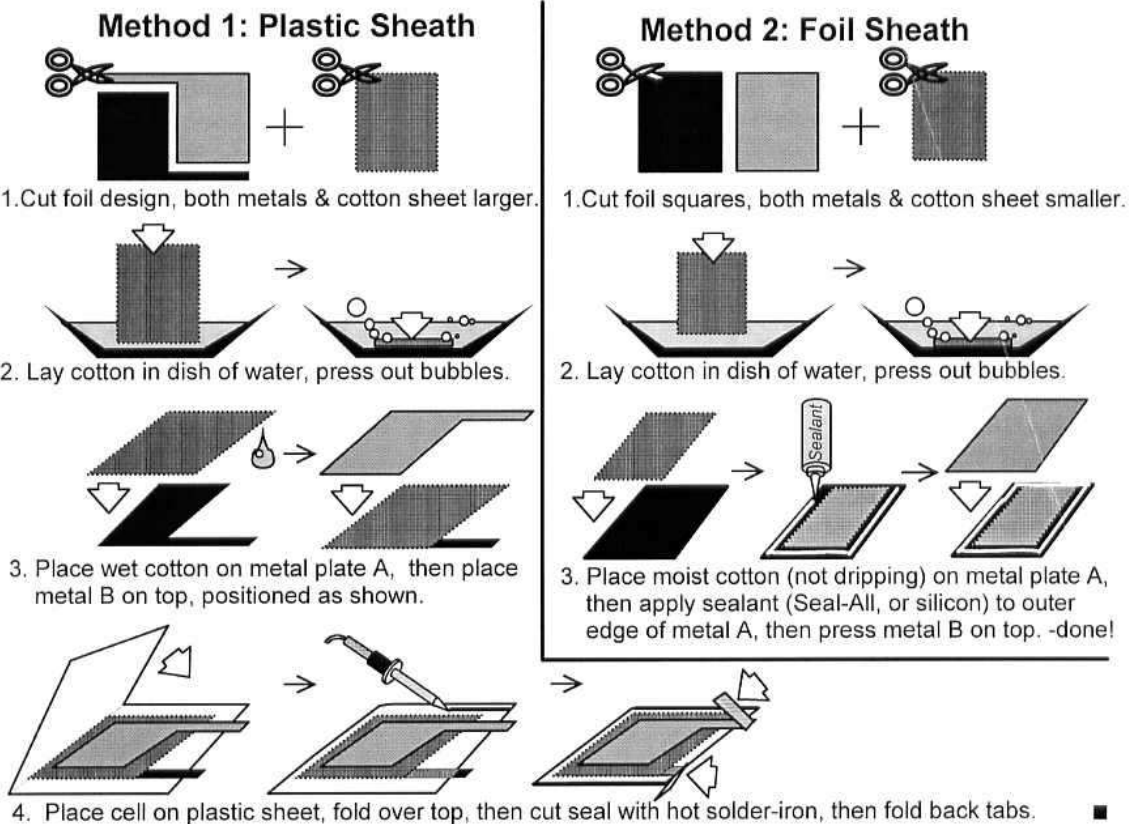

Free News

Sent in by one of our good customers out in California!
This guy went the extra mile and did an awesome job!

LAB NOTES, Water Battery 03-06-2001, page 2 of 2
(Details of Plastic Sheath type, -minuture 2"x1.378")

BONUS
Free News!

Cut foil design, metal A



Cutting foil, metal B



Filling cell with water



Sealing plastic with solder-iron



Shown after sealing/cutting



Bending back metal contacts



Measures .059 mA



Measures .421 vDC



Two cells measures .824 vDC



(Amperage approx. same as MetalSheath type cell shown previous page; but, voltage is less)

LAB NOTES, Water Battery 03-06-2001, page 1 of 2

Smoothing Plate under paper



Cotton sheet soaking in bowl

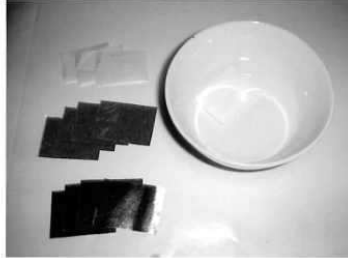

Cotton placed on metal plate A

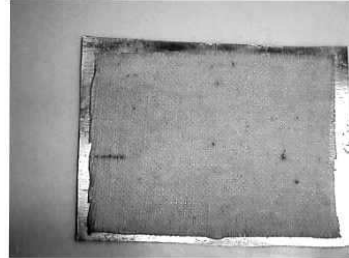

Applying sealant along edge

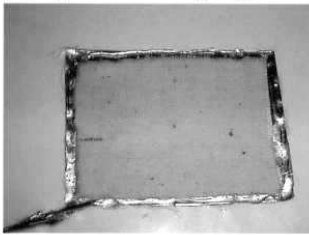

Pressing Metal plate B over A



Measures .507Volts DC



Measures .054 mA



10"x12" measure .196 mA



Pressing measure .521 vDC



BONUS
Free News

Pressing measure 1.048mA



Released measure .777mA



Later increases to .821mA Even Later .933mA



(Amperage was found to increase over time.)

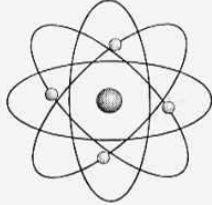

CREATIVE SCIENCE & RESEARCH

P.O. BOX 557 NEW ALBANY, IN. 47151

Information Big Brother & the Oil Companies do not want you to know!

KNOWLEDGE IS POWER!

+

4700 uF 35v

-

CONTACTS

RING

12 VDC coil 75 ma electromagnet

SIDE VIEW OF 4 PC

2003

FREE ENERGY

www.fuellesspower.com

Time is running out

